

Single sheave truck, cast aluminum revolving, non-fouling, internal halyard truck

### Model EC80 IH



www.flagpolewarehouse.com

1/8" x 7x19 Mil-C-5424 Stainless steel aircraft cable

Standard flag arrangement: 20' x 30'

Neoprene coated 2" diameter steel counterweight

Nylon beaded retainer ring

Gearless, self locking direct drive winch with six tumbler cylinder lock

Aluminum flash collar

3000 PSI concrete

Hardwood wedges (supplied by others)

Dry sand tightly tamped after aligning pole

Foundation sleeve -16 ga hot dip galvanized steel

Steel centering wedges

1/4" Steel base plate

1/4" Steel support plate welded to grounding spike

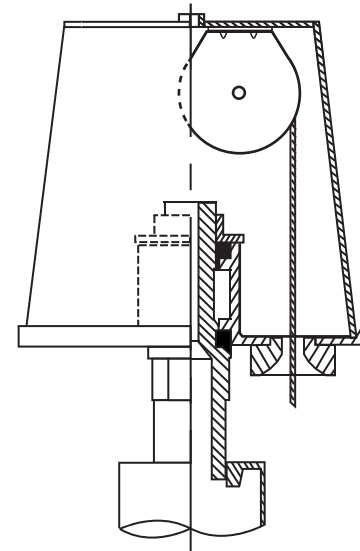
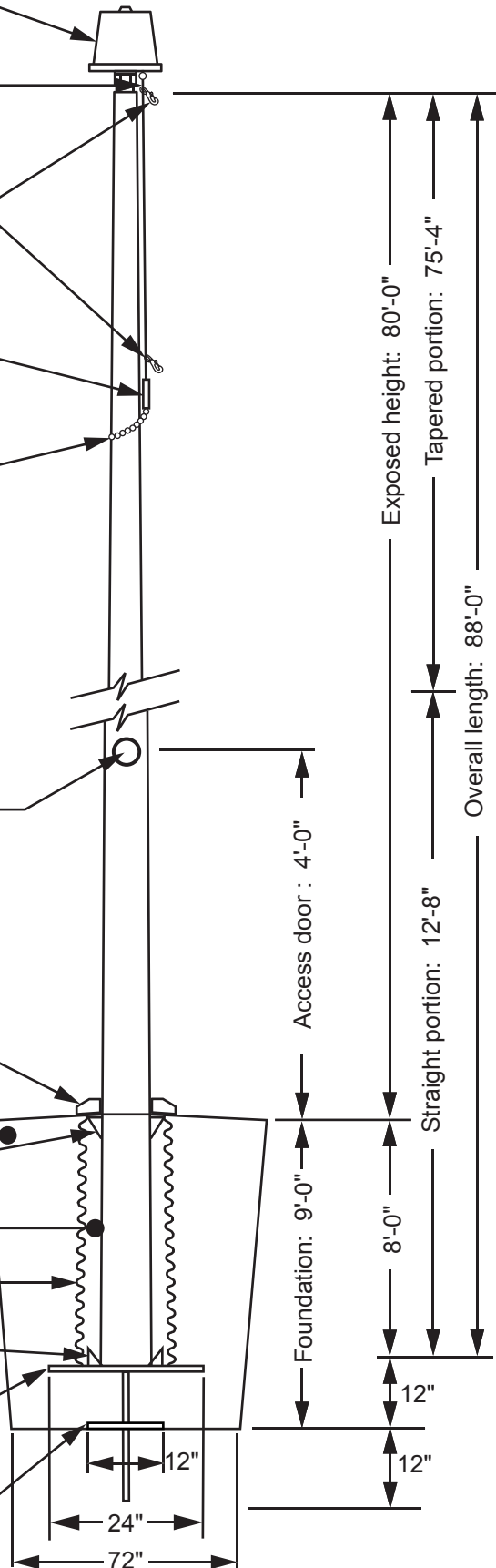

Revolving non-fouling internal halyard truck, cast aluminum body, 26 stainless steel ball bearings, and 2-1/2" diameter plated steel sheave.

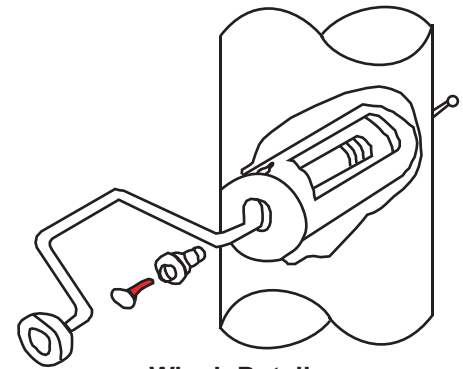

Winch Detail

All shafts with overall length of more than 38'-6" are shipped in two sections.

Each section matched marked for field assembly. Exposed portion of jam sleeve must be **well lubricated** prior to assembly.

1-1/2" maximum shop gap allowed for field fitting (ram for tight joint)

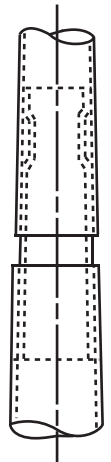

Project:	Ground set tapered aluminum flagpole: ALLOY: 6063T6	EDER FLAG	Date:
Location:	Exposed height: 80'-0"	Overall height: 88'-0"	MANUFACTURING COMPANY
Architect:	Ship in 3 sections	Butt diameter: 12"	1000 W. Rawson Avenue
Contractor:	Top diameter: 4"	Wall thickness: .375"	Oak Creek, WI 53154
Customer:	Finish: 100 grit polish		Job: